

**AVK** GAS SUPPLY



WE GUARANTEE SAFETY  
STANDARDS ARE MET  
**SO CAN YOU**

Expect... **AVR**





# LET'S TAKE SAFETY TO THE HIGHEST LEVEL

Leaks can be fatal. However, our strict quality control processes ensure reliable products that not only meet, but also exceed, the highest safety standards. All AVK valves are manufactured in our own state-of-the-art factories and thorough tests are carried out to safeguard the traceability, durability and operational reliability of our products.

For more than 40 years, AVK has successfully met the safety demands of natural gas companies. We have built a complete range of valves and accessories, and hold quality approvals of our gas valves from the leading national and international testing institutes.

Our quality assurance system is certified according to ISO 9001, and in 2018, we also obtained the ISO 29001 certification, an industry-specific standard for the oil and gas industry. Moreover, we are certified to ISO 14001, the international standard for environmental management, and to ISO 45001, the international occupational health and safety standard.

More than 4,800 people in the AVK group are doing their utmost to ensure that AVK remains one of the world's leading valve manufacturers for gas, water, wastewater, and fire protection applications.



# THE UNIQUE WEDGE IS THE HEART OF OUR GATE VALVES

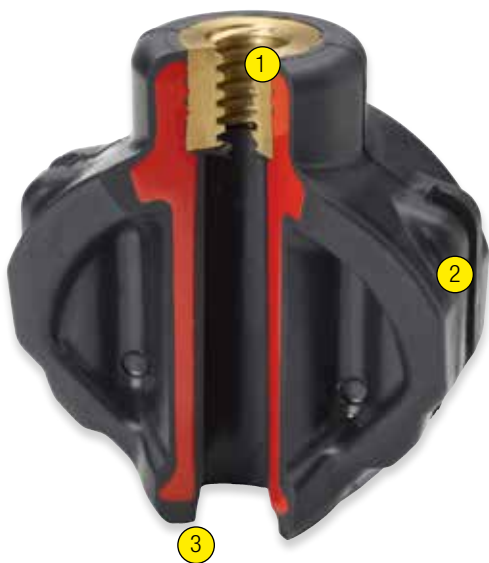

## Unique features and benefits:

- Fixed, integral wedge nut prevents corrosion (1).
- Double bonding vulcanisation process ensures maximum adhesion of the rubber.
- Guide rails with integrated wedge shoes ensure low friction and smooth operation (2).
- Rubber vulcanised to the core with min. 1.5 mm on all pressure bearing surfaces and 4 mm on all sealing surfaces gives optimum corrosion protection.
- Large rubber volume in the sealing area provides optimum sealing (3).
- AVK's own rubber compound features an outstanding compression set ensuring tight sealing even after having been compressed numerous times.

## Fixed wedge nut and integrated wedge shoes

AVK's wedge nut design with a fixed, integral wedge nut outperforms the traditional loose wedge nut design as it prevents vibration and thus also corrosion and malfunction.

The fixed wedge nut, combined with the guide rails with integrated wedge shoes, secure a smooth operation of the valve and low operating torques. The wedge shoes protect the rubber against wear which otherwise would arise caused by the friction during operation.

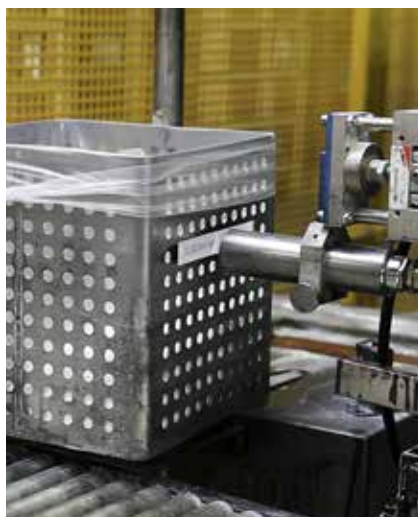



**State-of-the-art rubber technology**

AVK GUMMI A/S develops and manufactures the rubber compound for wedges and gaskets using highly advanced technologies.

Data is collected throughout the entire manufacturing process which secures traceability of every single ingredient, compound and final component. AVK performs a number of tests to ensure that the compression set values, the adhesion and the tensile strength meet the predefined requirements. Our NBR compound is approved according to EN 682.

**Efficient bonding is the key to durability**

The wedge core is immersed in two different baths to provide ultimate bonding between core and rubber. Even if a sharp object penetrates the rubber during closing of the valve, the bonding is so strong that there is no risk of creeping corrosion. As a result, we can offer the best possible rubber adhesion and corrosion protection of the wedge.

**Excellent ability to regain original shape**

AVK GUMMI A/S has a profound knowledge of a rubber's compression set, meaning its ability to regain original shape.

Even after many years of service where the wedge rubber has been compressed numerous times, the rubber will regain its original shape and ensure a tight sealing. Impurities will not affect the rubber surface or the tightness of the valve, as the impurities will be absorbed in the rubber when the valve is in closed position.

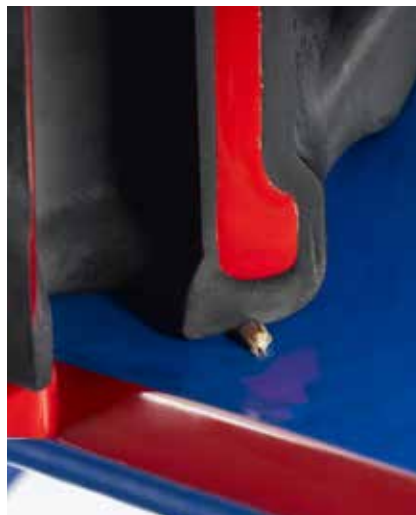

# HIGH STRENGTH STEM PROVIDING LOW OPERATING TORQUES



## Polished stems with rolled threads

The stem threads (1) are rolled in a cold pressing process which maintains the steel structure and therefore increases the strength of the stem. This method also ensures a smooth thread surface that gives low operating torques and prolonged durability. Finally, we polish the stems to provide a completely even interface (2) between the stem and the stem nut without risk of leakages.

## Wedge stop for extra safety

The stainless steel stems are designed with a wedge stop (3) providing a firm stop against the wedge nut when opening the valve. This prevents the wedge from compressing the stem seals and from damaging the coating inside the bonnet resulting in prolonged durability of the valve.



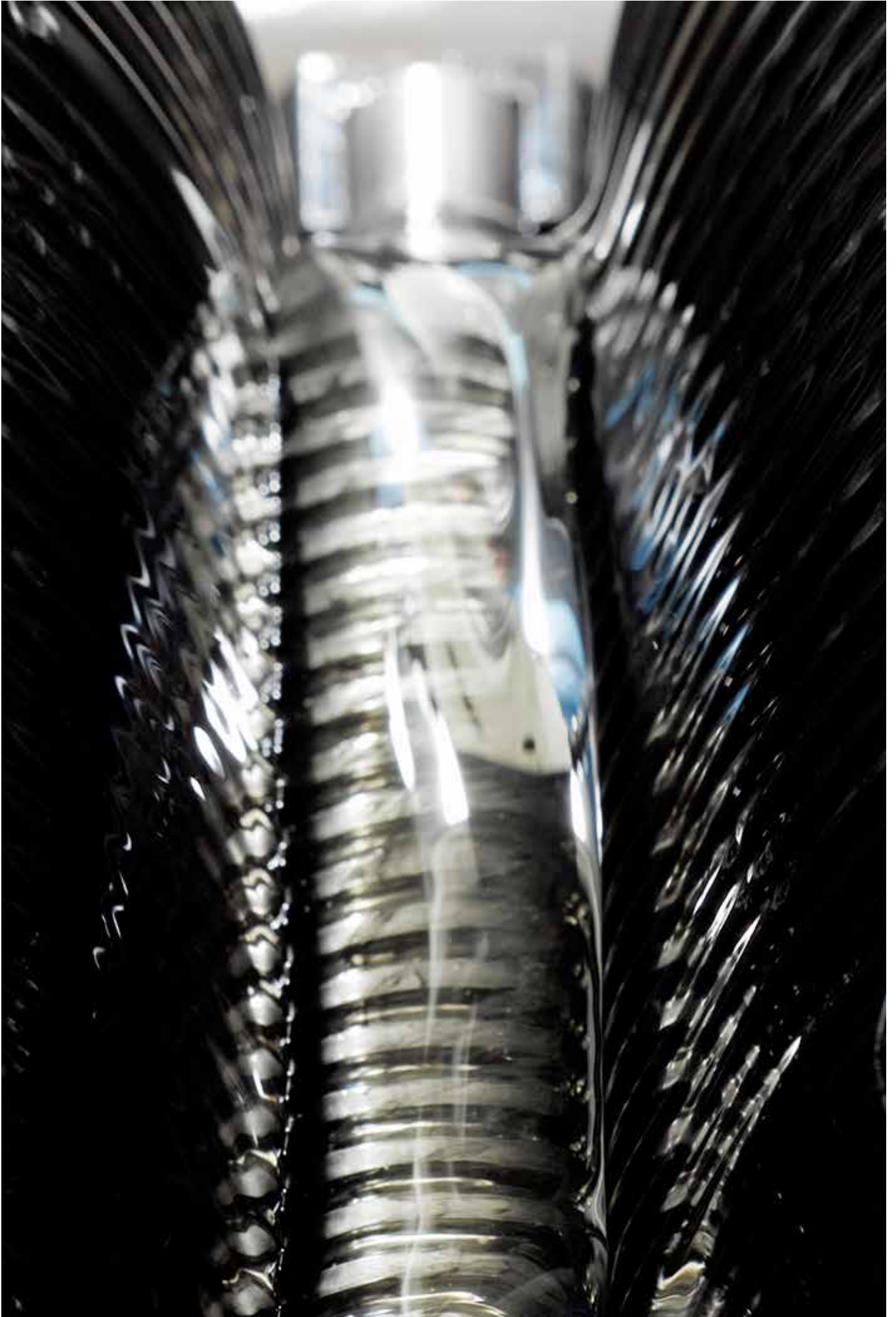

# CORROSION PROTECTION IN COMPLIANCE WITH GSK REQUIREMENTS

## Internal and external epoxy coating

All castings are blast cleaned according to ISO 12944-4. Any unevenness of the product surface is cleaned to provide perfect adhesion of the coating.

The epoxy is applied in a closed booth, either manually or in our automatic fluidised bed system, where the powder melts and cures in contact with the preheated component.

Thorough control measures are applied to ensure optimum corrosion protection in accordance with DIN 3476 part 1, EN 14901 and GSK requirements.







**Thorough tests of the epoxy coating**

We check each batch of epoxy coated components to ensure a layer thickness of minimum 250 µm and a pore-free surface.

The coating must be completely free of penetrating pores to avoid subsequent corrosion of the casting underneath. A 3000 V holiday detector with a brush electrode is used to electrically reveal and locate any pores in the coating. The PUR coating can also give an additional protection of a valve when installed in aggressive soils.

The impact resistance test is carried out by means of a stainless steel cylinder dropped on the coating surface through a one meter long tube corresponding to an impact energy of 5 Nm. After each impact the component is electrically tested, and no electrical break-through shall occur.

The curing of the epoxy coating is checked in a cross linkage (MIBK) test, where one drop of methyl isobutyl ketone is put on a horizontal epoxy coated surface of a test piece. After 30 seconds the test area is wiped with a clean white cloth. It is checked that the test surface has not become neither matt nor smeared, and that the cloth remains clean.

**Galvanic corrosion prevention**

For more than 30 years, we have offered a highly resistant polyurethane (PUR) coating as an option for our gas valves.

Polyurethane gives outstanding protection of the valve against galvanic corrosion, shielding the valve completely from its surroundings, and in addition, polyurethane eliminates any risk that electrical currents will penetrate the valve. PUR coating can also give additional protection of a valve installed in aggressive soils.

The polyurethane coating is quality tested according to EN10290 type 2, class B. This means that the dried coating layer will always have a minimum thickness of 1500µ (1.5 mm). After curing, the PUR coating of every single valve is checked for holidays at 20 kV (20,000 volts). The coating is only approved if no pinholes are detected.



The photo above shows a fully functional PUR coated AVK valve produced in 1989 that has been excavated after 21 years of operation. The valve had to be opened by an angle grinder due to the robustness of the coating, and the valve was still in perfect condition.



# NO COMPROMISE ON TIGHTNESS AND TRACEABILITY



## Triple safety in the stem sealing system

An NBR wiper ring (1) protects against impurities from the outside. Tightness and low friction are provided by four NBR O-rings in a stem seal nut (2), which is replaceable under pressure. An NBR manchette (3) is the main seal to the flow and prevents leakage in the rare case that the stem seal nut needs to be replaced.

## Tight assembly of valve body and bonnet

An NBR bonnet gasket (4) fits into a recess between the valve body and the bonnet. The stainless steel bonnet bolts (5) are encircled by the bonnet gasket, countersunk in the bonnet and finally sealed with hot melt to prevent corrosion.

## Full bore prevents pressure loss

A full bore with the same nominal diameter as the pipeline ensures minimum pressure loss, as the valve does not cause any reduction in the flow path.

## 100% pressure test and traceability

Every single valve is pressure tested to DIN 3230-5, PG 3 / EN 13774 before leaving the factory.

In open position:

1.5 x with water

0.5 bar with air

1.1 x with air

In closed position:

0.5 bar and 1.1 x with air, from both sides

When the valve has successfully passed the pressure test, the serial number is stamped on the valve stem and noted in the pressure test report for documentation.





# PE END CONNECTION STRONGER THAN THE PIPE ITSELF

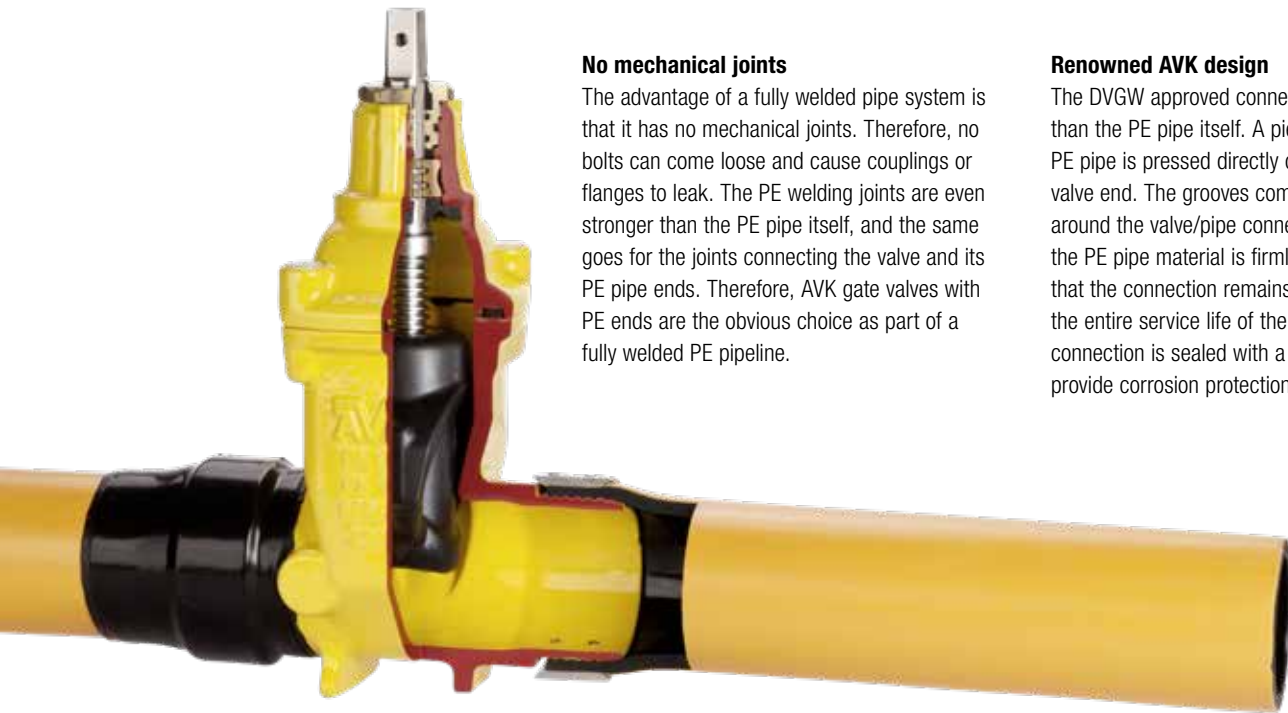

## No mechanical joints

The advantage of a fully welded pipe system is that it has no mechanical joints. Therefore, no bolts can come loose and cause couplings or flanges to leak. The PE welding joints are even stronger than the PE pipe itself, and the same goes for the joints connecting the valve and its PE pipe ends. Therefore, AVK gate valves with PE ends are the obvious choice as part of a fully welded PE pipeline.

## Renowned AVK design

The DVGW approved connection is stronger than the PE pipe itself. A piece of standard PE pipe is pressed directly onto the grooved valve end. The grooves combined with a sleeve around the valve/pipe connection ensure that the PE pipe material is firmly secured and that the connection remains tight and tensile the entire service life of the pipeline. The connection is sealed with a shrink hose to provide corrosion protection.



# GATE VALVES WITH PE ENDS - A NATURAL PART OF PE NETWORKS



## Get all the benefits

With a fully welded PE pipe system including valves, you get all the installation benefits of PE pipes. PE pipes are flexible and follow the terrain, so there is no need to level the soil in the trench. PE pipes are easy to handle and are typically welded above ground for easy installation. One of the strengths of AVK gate valves with PE ends is that the same welding parameters can be used throughout the entire network, since standard PE pipes are mounted on the valves. Thanks to the extra-long PE ends of the valves, there is even room for an extra weld, if needed.

## Direct welding into PE pipes

AVK gate valves with PE ends enable direct welding into PE pipes by using socket fusion or butt welding. The full, straight bore ensures minimum pressure loss and makes under pressure drilling possible.

The valves are available with PE X PE connection in DN80-400, with flange X PE connection in DN50 X200 and with steel spigot end X PE connection in DN 50-300.

## Foundation provides stability

Valves in DN50-100 can be equipped with a foundation that secures the stability of the valve and prevents opening or closing torques from being transferred to the PE pipe. The foundation is made of hot-galvanised steel and includes two plastic straps for fixation of the valve.



# GATE VALVES FOR WELDING INTO LOW PRESSURE STEEL PIPES



## Complete range up to DN600

AVK gate valves with steel spigot ends are available in DN50 to 600. We offer two different face-to-face dimensions both offering easy access to the welding ends, and optionally with ISO top flange prepared for mounting of electric actuator. The low weight facilitates easy handling of the valves on site. The valves are made of cast steel GP240GH with welding ends according to DIN 3239 part 1. The welding process is performed by certified welders.

All welds undergo non-destructive X-ray testing, which means that the valves comply in full with the requirements of PED (Pressure Equipment Directive) 2014/68/EU.

All tests are carried out by a certified inspection company. The examination procedure is according to EN ISO 17636-1, and the acceptance criteria according to EN ISO 10675-1.



Gate valve with up- and downstream purge points



# FLANGED AND SERVICE CONNECTION VALVES COMPLETE THE RANGE



## Service connection valves

AVK service connection valves feature the same basic construction as the main-line gate valves except for the wedge design. The wedge core is made of dezincification resistant brass which is vulcanised with NBR rubber externally. The wedge is shaped with wedge guides, and a patented rubber profile ensures low closing torques.

AVK service connection valves are available with internal thread and with PE ends for welding into PE pipes.

## Flanged gate valves

Flanged gate valves can be used for almost any application. AVK flanged gate valves are available in two different face-to-face dimensions and with standard bonnet, ISO flange bonnet or with position indicator:

- Long, according to EN 558 table 2 basic series 15 (DIN F5), DN40-500
- Long, with position indicator, DN400-500
- Short, according to EN 558 table 2 basic series 14 (DIN F4), DN40-600
- Short, prepared for actuator with ISO top flange, DN50-400
- Short, with position indicator, DN50-400



# PE BALL VALVES FOR LOW PRESSURE APPLICATIONS

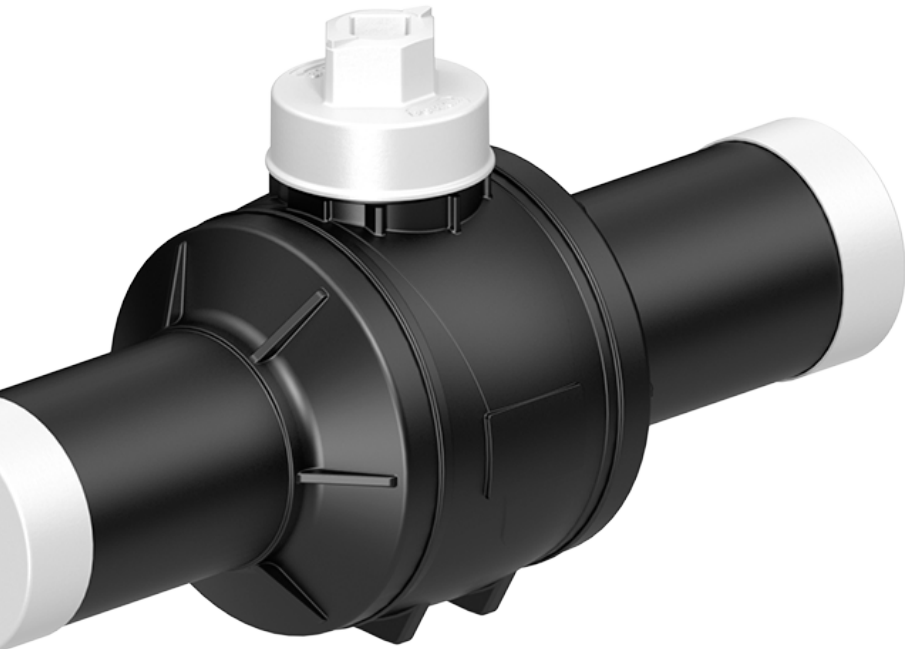

## Valve range

AVK CERTUS PE ball valves are available from OD20 up to OD180 mm. Depending on the requested pressure rating the valves are available with SDR11 or SDR17.6 spigot ends.

## Full traceability

AVK PE ball valves are produced with state-of-the-art machinery to guarantee a consistent high quality. We are able to trace components throughout the manufacturing process from initial injection moulding over machining and welding to final batch release test. Every valve is given a unique serial number which can be traced back to the raw polyethylene material.

## Approvals and type testing

CERTUS valves are fully type tested at an external worldwide reputable laboratory. The valves meet all requirements in EN1555-4, ISO4437-4, GIS/V7-2 and EN12201-4.

During type testing, the valves are not only submitted to various long and short term leaktightness checks, but also to rigorous pulling, bending and thermal cycling tests. The operating mechanism and top cap can withstand high torques at extreme temperatures.

## Full bore

Body and spigots are made of high performance PE100, and the valves can be welded to all PE100 and PE80 pipes. A full bore ensures a low pressure drop and greater flow through the valve at the same pressure. The large bore also allows for pigging of pipes.

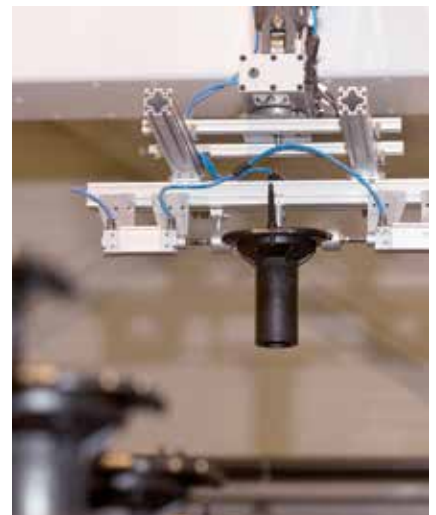





(1) If the valve is over torqued, the top cap is designed to fail before the valve seals fail, thus preventing leaks. The safety top cap can be replaced easily under live conditions.



(2) Triple O-ring construction around the stem guaranteeing sealing safety

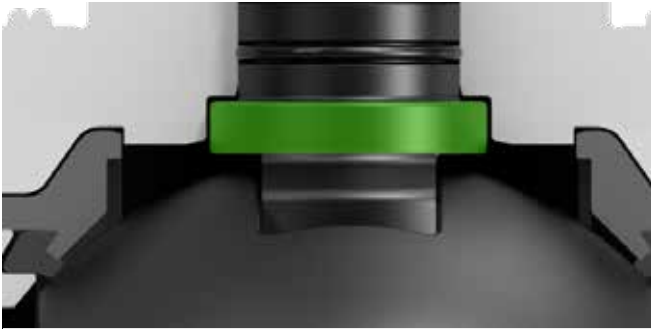

(3) The intentionally over-designed stem is extremely strong and of the anti blow-out type.

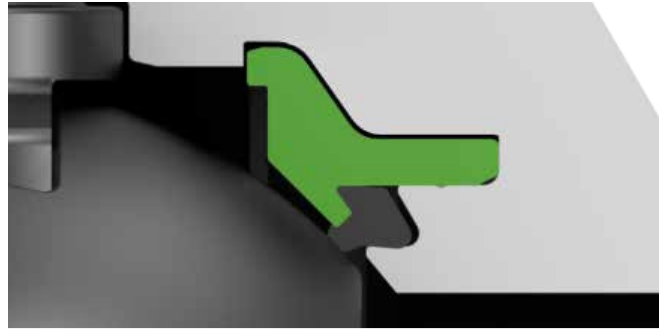

(4) The seat retainer design ensures the ball seat is kept in place. It prevents the ball seat from being dislodged, which guarantees a good functionality throughout the years.

#### Safety top cap prevents leaks

If the valve is over torqued during opening or closing, the top cap is, as a safety feature, designed to fail before the valve seals fail in order to prevent leakage. The safety top cap is replaceable under live conditions.

#### Optimised stem sealing

The ball valves are equipped with two weather seals (1) avoiding ingress of ground water and dirt into the operating mechanism. The stem (3) is of the anti blow-out type and has a triple O-ring seal (2) to guarantee safety at all times.

#### Sealing at all times

The seat retainer design (4) ensures that the ball seat is kept in place. The floating ball principle and special shaped ball seats are designed to ensure sealing at all times and be less affected by dirt or debris.

#### Spigot end construction

The spigots are butt welded to the body. Visual beads ensure a high joint quality of each weld in the complete pipeline. The spigot ends are machined on the inside as well as on the outside, guaranteeing a uniform wall thickness and allowing for optimal welding of electro fusion couplers. The smooth inner surface prevents deposits and minimises flow resistance.

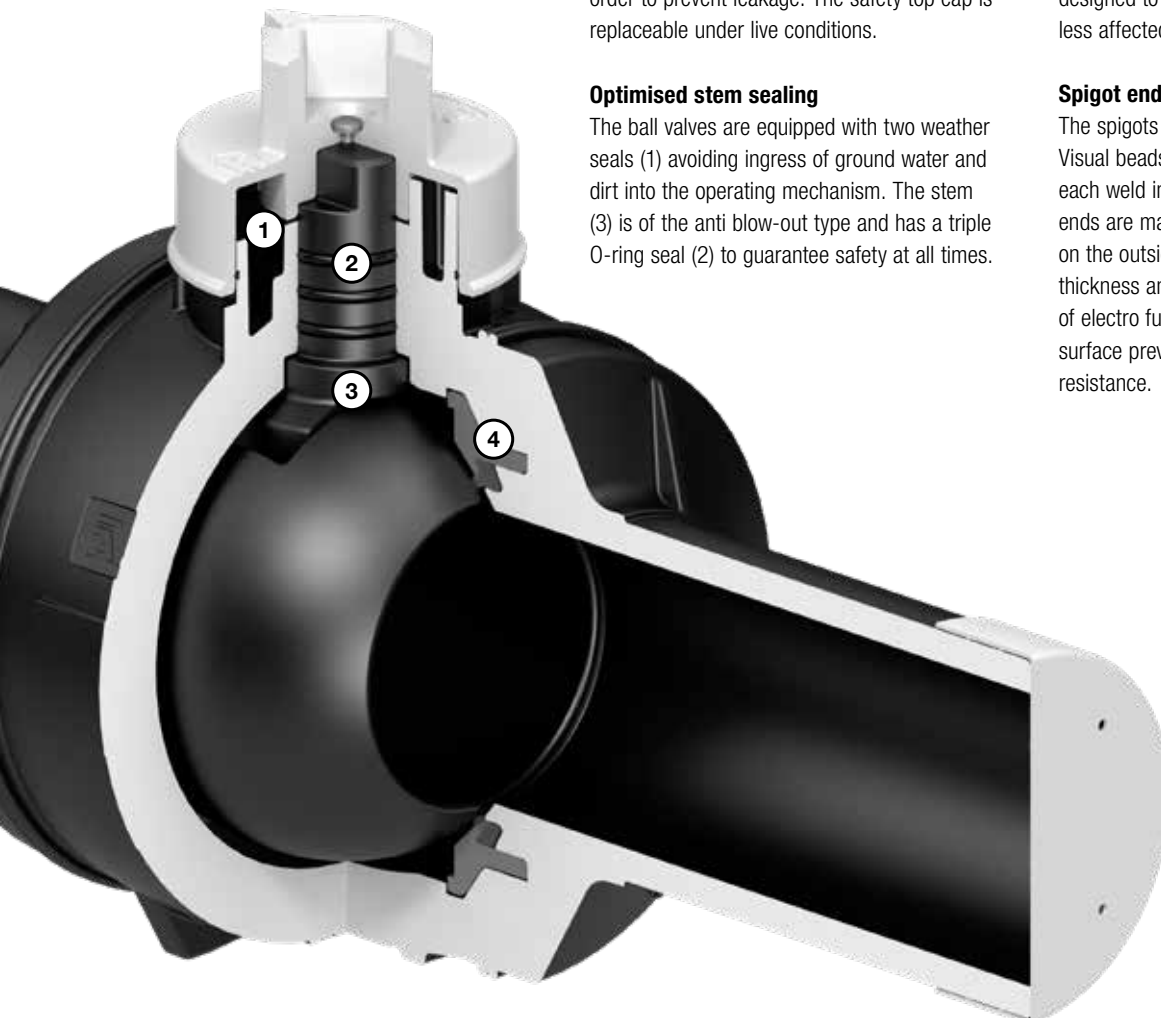

# BUTTERFLY VALVES FOR ABOVE GROUND INSTALLATIONS



## Renowned centric butterfly design

The butterfly valves are produced by Wouter Witzel EuroValve, a well-esteemed company in the AVK Group, and one of very few manufacturers of butterfly valves with fixed liner. The Wouter Witzel butterfly valves are approved by all major authorities such as KIWA, DVGW, SVGW, and WRC.

## Cost efficient installation

The compact lightweight construction saves space and makes the valves easy to handle. The streamlined disc shape ensures minimum turbulence and head loss. Furthermore, the low torques facilitate the operation of the valves allowing the use of smaller and less expensive actuators.

## Outstanding seating concept

The rubber is injection moulded directly on the valve body forming a permanent bond with an optimal rubber shore hardness. Consequently, there is no risk of deformation or dislocation of the liner making the valves suitable under vacuum conditions.

The disc has a profiled sealing edge which requires minimal deformation of the liner to achieve a tight sealing. This gives less wear of the liner and low operating torques. Therefore, the butterfly valves are the ultimate choice for applications with high operation frequency.



# REPAIR CLAMPS FOR QUICK REPAIR OF LEAKAGES



## Cost-effective repair

Our stainless steel repair clamps are used worldwide for repair of leakages and ruptures in pipe systems. The design ensures a cost-effective and reliable solution for quick repairs of steel, copper, asbestos cement, cast iron and plastic pipes. Repair clamps may be used for permanent repair of punctures as well as longitudinal and circumferential cracks.

The functional principle of the repair clamp is based on a stainless steel, pre-rolled plate which is clamped around the pipe and fastened with lugs and nuts. After welding, the clamp will be completely pickled and passivated in order to ensure corrosion resistance. AVK repair clamps are provided with a waffle structured rubber gasket and rounded tops to create a fully circumferential seal.

## Complete range of stainless steel clamps

The range includes a single band clamp with diameters ranging from 48-52 mm to 350-360 mm, a double band clamp ranging from 88-110 mm to 590-610 mm, and a triple band clamp ranging from 270-300 mm to 810-840 mm. Other dimensions are available upon request.

The clamps are available with or without BSP thread, in lengths of 100-900 mm with intervals of 100 mm, and in stainless steel AISI 304 or AISI 316. They are designed with NBR rubber lining, teflon coated A2 bolts, and teflon coated A4 nuts. Clamps for DN600 to 2000 pipes are also part of the range.



# EXTENSION SPINDLES IN A DURABLE AND USER-FRIENDLY DESIGN



## Complete range

Extension spindles are used for easy access to operation of valves installed below ground. AVK extension spindles are produced on fully automated state-of-the-art production equipment to ensure cost efficiency and a uniform quality.

The extension spindles are available in telescopic and fixed length designs for gate valves as well as for service connection valves. Furthermore, they are available in telescopic design for PE ball valves.

The extension spindles are made of corrosion-resistant materials to ensure long service life. The conical key adaptor fits standard T-keys. The bottom cover protects the valve spindle from impurities and enables it to rotate freely.

## Fixed length design features easy shortening

The patented AVK design facilitates fast and easy shortening of the extension spindle. The complete adjustment of the length can be done merely by use of a hacksaw. The extension spindles are available with a pipe cover of 800-1000-1500-2000-3000 mm.

## Telescopic design facilitates on-site adjustments

The top adaptor is designed with a defrosting hole and with ears that can be fixed into AVK surface boxes and support tiles. A lock spring prevents the telescopic part from collapsing during installation, as it creates friction inside the inner tube.

The blue center sleeve protects against penetration of impurities between the two outer PE pipes.

## Telescopic extension spindles with break zone

We also offer variants with break zone in the key adaptor which prevents damage of the valve in cases where too much torque is applied. In such cases the break nut is easily replaced, and the extension spindle can still be operated by means of a #20 socket wrench. Spare part sets are available.



Expanding bolt design facilitates easy height adjustment on fixed length extension spindles.



The top spanner and the inner tube are press fit.



The breakzone prevents damage of the valve.



**“Safe-click” for service connections**

Both the fixed and the telescopic extension spindles feature a patented “Safe-click” mounting system. “Safe-click” offers a secure and fast three-step mounting process on service connection valves.

The spindle adaptor of the extension spindle is placed on top of the valve stem. The split fitted on the bottom cover is inserted in the hole of the spindle adaptor and valve stem, and the bottom cover is pressed down until “click”.



# SURFACE BOXES LIGHTWEIGHT AND SUSTAINABLE



## Why choose synthetic surface boxes?

- Lightweight, ensuring safe and easy handling in compliance with Health and Safety Regulations
- Maintenance and corrosion free. Easy access throughout the year; no need to clean or grease the seat to protect against corrosion or frost
- Silent in traffic zones; synthetic material absorbs noises
- 100% recyclable and significantly less use of energy resources compared to the production of cast iron surface boxes
- Heat resistant max. 250°C

## Designed for tough conditions

The housing of synthetic surface boxes is made from specially compounded PA+ (polyamide with additives), making the surface box suitable for heavy duty application areas in all seasons and conditions.

The material has high impact resistance at low temperatures and is sufficiently heat resistant for safe installation in tarmac roads. The ribs in the housing ensure optimal fixation in the road foundation.

## Height adjustable surface boxes

AVK offers a wide range of DIN DVGW approved height adjustable surface boxes specifically designed for tarmac installation. The use of height adjustable surface boxes enables easy and precise installation thanks to flexible positioning of the top part. Height adjustable surface boxes prevent costly correction after installation and save time and money when roads are renovated.

AVK also offers height adjustable surface boxes with reinforced rim, ensuring better support of the top part and making this product even more robust, stable and suitable for heavy duty application areas.

## Fixed height surface boxes

Our Classic fixed height surface boxes are DIN DVGW approved and designed to withstand heavy traffic loads. Therefore, they are often used in medium and heavy duty application areas.

Our Futura range is a lightweight and price competitive version and is often used in light to medium duty application areas.





### Recognisable synthetic lids

Lids made of synthetic material are corrosion free, unattractive to thieves, more aesthetic (making them highly suitable for shopping areas and city centres) and lightweight, and in compliance with Health and Safety Regulations.

To prevent the lid from being lifted by the suction of a passing vehicle, the reduced weight is compensated for with a locking clip around the bolt. In the event that surface box lids get covered with snow, leaves or soil, AVK offers a solution that makes the surface box easily detectable by means of a ferromagnetic detector.

### Support tiles and top frames

Support tiles significantly increase the support required by surface boxes in weak soils. They also prevent telescopic extension spindles from being pushed back.

Top frames protect surface boxes in green zones and improve the visibility of the surface box. Synthetic top frames are lightweight, especially compared to concrete top frames. With a top frame, grass will not overgrow the surface box and combined with a support tile, easy access to valves installed below is guaranteed.

### Flexible floating surface boxes

The deflection ability secures optimal fit on sloped surfaces. The internal fixation of telescopic extension spindles enables height adjustment after installation. The large chamber provides easy access for mounting and demounting of the extension spindle, and the closed design protects the extension spindle against impurities.

The surface boxes are available with square or circular surface plates. The body is made of polyamide PA-6, and the surface plate and lid are of ductile iron with black primer. The lids are also available with yellow epoxy coating.



# SUPA MAXI™ UNIVERSAL TENSILE COUPLINGS



## Innovative design with unique features

AVK offers a complete range of universal tensile couplings comprising straight, step and transition couplings as well as flange adaptors and end caps complying to the EN 14525 standard. Supa Maxi™ sets a new standard with its unique features:

- Fully universal and tensile
- Patented SupaGrip™ sealing support system
- PN10 in all dimensions
- $\pm 4^\circ$  ( $8^\circ$ ) angular deflection on each side
- Permanent protection caps provide protection during handling and installation
- Bolts are tightened on the bolt head from the sleeve side, no re-tightening
- Lifting eye in DN100-400
- Fusion bonded epoxy coating in compliance with DIN 3476 part 1 and EN 14901, GSK approved
- Gasket of NBR approved for gas
- Temperature range  $-20^\circ\text{C}$  to  $+70^\circ\text{C}$

## Cut time on installation

Supa Maxi™ couplings enable  $\pm 4^\circ$  (in total  $8^\circ$ ) deflection on each side up to a maximum pressure of PN10.

All items with a weight exceeding 10 kilos are designed with a lifting eye in the sleeve enabling easy and ergonomically safe handling.

Due to the all-metal SupaGrip™ sealing support system, re-tightening of the bolts is not necessary.

During handling, the center piece of the protection cap protects against the sharp grip segments and prevents impurities from settling inside the coupling.





Before tightening



After tightening



The large insertion depth tolerances allow the pipe to be cut slightly angled and the pipe will not move inwards when tightening the bolts. This gives a simple installation without need for precise adjustment.

**Superiour tightness on all pipe materials**

SupaGrip™ provides full support and backup of the gasket even on minimum pipe sizes within the tolerance range and when used on oval pipes. The flexible bracket is designed to contract and follow the external pipe diameter. As a result, it serves as a solid backup for the gasket and enables full deflection.

When tightening the bolts, the bracket segments and radially moving bolts move inwards, securing that the gasket tightens around the pipe and that the grip segments clutch the pipe surface.

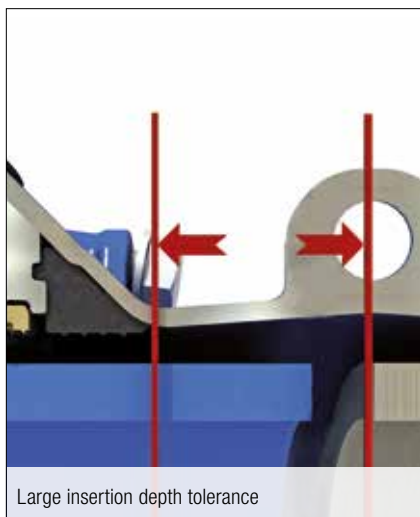

Large insertion depth tolerance

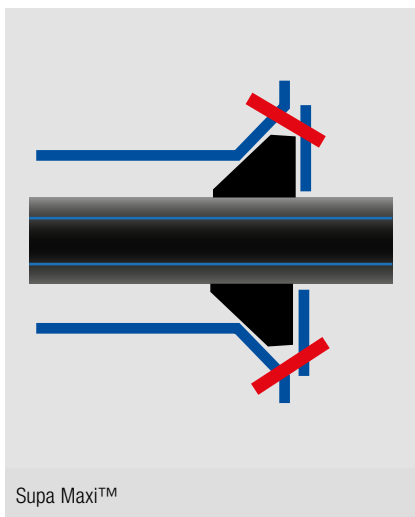

Supa Maxi™

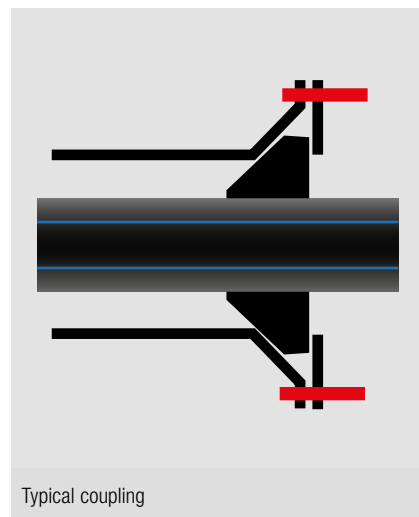

Typical coupling

# GATE VALVES



**Series 36/90**  
Gate valve with PE ends  
DN65-400  
PE100/PN10 SDR 11  
pipes

Ductile iron  
With external epoxy  
coating

- Options:  
• PE100/PN10/4 pipes



**Series 36/90**  
Gate valve with PE ends  
DN65-400  
PE100/PN10 SDR 11  
pipes

Ductile iron  
With external PUR  
coating

- Options:  
• ISO top flange



**Series 38/90**  
Gate valve with flange/  
PE end  
DN50-200  
PE100 / PN10 SDR 11  
pipe

Ductile iron  
With external epoxy  
coating



**Series 46/64**  
Gate valve with short  
spigot ends  
DN50-300  
PN16  
GP240GH  
With external epoxy  
coating

- Option:  
• external PUR coating



**Series 46/70**  
Gate valve with long  
spigot ends  
DN50-600  
PN16  
GP240GH  
With external PUR  
coating

- Option:  
• external epoxy coating



**Series 46/80**  
Gate valve with long  
spigot ends and two  
purge points  
DN80-600  
PN16  
GP240GH  
With external PUR  
coating



**Series 46/78**  
Gate valve with long  
spigot ends and ISO top  
flange  
DN50-400  
PN16  
GP240GH  
With external PUR  
coating

- Option:  
• external epoxy coating



**Series 46/90**  
Gate valve with steel/PE  
spigot ends  
DN50-300  
PN10  
GP240GH

External epoxy coating

- Options:  
• external PUR coating



**Series 02/70**  
Flanged gate valve  
Long DIN F5  
DN40-500  
PN10/16  
Ductile iron  
With external epoxy  
coating



**Series 06/70**  
Flanged gate valve  
Short DIN F4  
DN40-600  
PN10/16  
Ductile iron  
With external epoxy  
coating



**Series 06/59**  
Flanged gate valve  
with position indicator  
Short DIN F4  
DN50-400  
PN10/16  
Ductile iron  
With external epoxy  
coating

- Option:  
• long DIN F5, DN400-  
500



**Series 15/78**  
Flanged gate valve  
with ISO top flange  
Short DIN F4  
DN50-400  
PN10/16  
Ductile iron  
With external PUR  
coating

- Option:  
• external epoxy coating

# SERVICE CONNECTION VALVES, COUPLINGS, BUTTERFLY VALVES AND BALL VALVES



**Series 36/9X**  
Service connection valve with PE ends  
DN25-50  
PE100 / PN10 or 4 pipes

Ductile iron  
With external epoxy coating

Options:  
• external PUR coating



**Series 03/25**  
Service connection valve with internal thread  
DN25-50  
PN4  
Ductile iron  
With external epoxy coating



**Series 631/70**  
Supa Maxi™ universal tensile straight coupling  
DN50-400  
PN10  
Ductile iron

Options:  
• step coupling



**Series 633/70**  
Supa Maxi™ universal tensile flange adaptor  
DN40-400  
PN10  
Ductile iron



**Series 634/70**  
Supa Maxi™ universal tensile end cap  
DN50-300  
PN10  
Ductile iron



**Series 75/11**  
Wafer butterfly valve, centric with fixed liner  
DN50-600  
PN10/16  
Ductile iron



**Series 75/31**  
Semi-lug butterfly valve, centric with fixed liner  
DN50-300  
PN10/16  
Ductile iron

Options:  
• full lug



**Series 75/20**  
Double flanged short butterfly valve, centric with fixed liner  
DN50-600  
PN10/16  
Ductile iron

Options:  
• double flanged long



**Series 85/30**  
Ball valve with spigot ends  
DN25/Ø20 mm - DN150/Ø180 mm  
PN10  
PE100

Options:  
• lever  
• support base

# SURFACE BOXES AND SUPPORT TILES



**Series 80/31**  
Surface box "Futura" for gate valves  
Fixed height  
Body of PA+  
Lid of yellow PA

Options:  
• lid of cast iron or black PA for pavement



**Series 80/32**  
Surface box "Futura" for service connection valves  
Fixed height  
Body of PA+  
Lid of yellow PA

Options:  
• lid of cast iron or black PA for pavement



**Series 80/33-000**  
Surface box for service connection valves, design derived from DIN 4059  
Fixed height  
Body of PA+  
Lid of cast iron



**Series 80/33-100**  
Surface box for service connection valves, design derived from DIN 4059  
Height adjustable  
Body of PA+  
Lid of cast iron



**Series 80/33-400**  
Surface box for service connection valves  
Height adjustable  
Reinforced rim  
Body of PA+  
Lid of cast iron



**Series 80/34-000**  
Surface box for gate valves to DIN 3581  
Fixed height  
Body of PA+  
Lid of cast iron



**Series 80/34-100**  
Surface box for gate valves to DIN 3581  
Height adjustable  
Body of PA+  
Lid of cast iron



**Series 80/34-400**  
Surface box for gate valves, design derived from DIN 3581  
Height adjustable  
Reinforced rim  
Body of PA+  
Lid of cast iron



**Series 80/35**  
Surface box for gate valves to DIN 3582  
Height adjustable  
Body of PA+  
Lid of cast iron

Options:  
• fixed height



**Series 80/36**  
Surface box for gate valves to DIN 3583  
Fixed height  
Body of PA+  
Lid of cast iron

Options:  
• height adjustable  
• synthetic lid  
• to DIN 3584



**Series 80/46**  
Support tile for surface boxes for gate valves and service connection valves  
With spindle fixation  
PA+

Options:  
• without spindle fixation



**Series 80**  
Top frame for surface boxes for gate valves and service connection valves  
PA+

# EXTENSION SPINDLES, REPAIR CLAMPS AND GASKETS



**Series 04/05**  
 Extension spindle for service connection valves  
 Fixed length  
 DN25-50  
 Pipe cover 800-3000 mm



**Series 04/07**  
 Extension spindle for service connection valves  
 Telescopic  
 DN25-50  
 Length 450-700 to 1700-2900 mm



**Series 04/02**  
 Extension spindle for gate valves  
 Fixed length  
 DN40-400  
 Pipe cover 800-3000 mm



**Series 04/04**  
 Extension spindle for gate valves  
 Telescopic  
 DN50-600  
 Length 450-700 to 2850-5250 mm



**Series 04/F**  
 Extension spindle for PE ball valves  
 Telescopic  
 DN25-150  
 Length 450-700 to 2850-5250 mm



**Series 748/01**  
 Repair clamp  
 Single band with support plate  
 Stainless steel AISI 304 or AISI 316  
 NBR rubber

Options:  
 • fingers  
 • handgrip



**Series 748/02**  
 Repair clamp  
 Single band with support plate  
 Stainless steel AISI 304 or AISI 316  
 NBR rubber

Options:  
 • fingers  
 • handgrip



**Series 748/03**  
 Repair clamp  
 Triple band with support plate  
 Stainless steel AISI 304 or AISI 316  
 NBR or EPDM rubber

Options:  
 • fingers

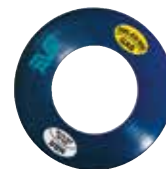

**Series 79/B**  
 Flange gasket in straight KGS design  
 NBR rubber  
 DN50-800

Options:  
 • Drop-shaped KGS-S design

# EXPECT US TO EXCEED MARKET STANDARDS

## Inhouse R&D

In our Development Department in Denmark, ideas and suggestions for new products are gathered, and existing products are updated continuously.

We use FEA (Finite Element Analysis) to optimise the strength and geometry of our components and CFD (Computational Fluid Dynamics) analyses to validate different product designs prior to creating physical prototypes, enabling us to predict consequences in cases where it is impossible to create full scale tests on physical products.

We make our own test and production equipment, and in our flow lab, we conduct thorough prototype and life cycle tests prior to release for production. New product types are generally field tested in co-operation with end users before final launch.

## Certified according to ISO/TS 29001:2010

ISO 29001 is an industry-specific standard for the oil and gas industry based on ISO 9001, but with stricter requirements for control measures and risk management, in that key issues such as staff training, traceability of materials and obtained test results must be documented.

Moreover, we are certified to ISO 14001, the international standard for environmental management, and to ISO 45001, the international occupational health and safety standard.

## Expect... AVK

In our business there are five cornerstones that must be in place in order to meet customer expectations: Quality, reliability, innovation, sustainability and customer service.

But we need to go further than that. We go further to exceed our customers' needs and expectations.

"Expect... AVK" means that our customers should rightfully expect us to exceed market standards. "Expect... AVK" means that we relentlessly strive for increased customer benefits!

To ensure that we keep pushing the boundaries of what the market can expect, we have formulated promises that we will strive to deliver in all our markets:

- EXPECT** A LONG-TERM PARTNERSHIP
- EXPECT** QUALITY IN EVERY STEP
- EXPECT** LASTING INNOVATIONS
- EXPECT** TOTAL SAVINGS
- EXPECT** SOLUTIONS, NOT JUST PRODUCTS
- EXPECT** GLOBAL LEADERSHIP AND LOCAL COMMITMENT
- EXPECT** PROMPT RESPONSE
- EXPECT** IT TO BE EFFECTIVE AND EASY

See more on [www.avkvalves.eu](http://www.avkvalves.eu)



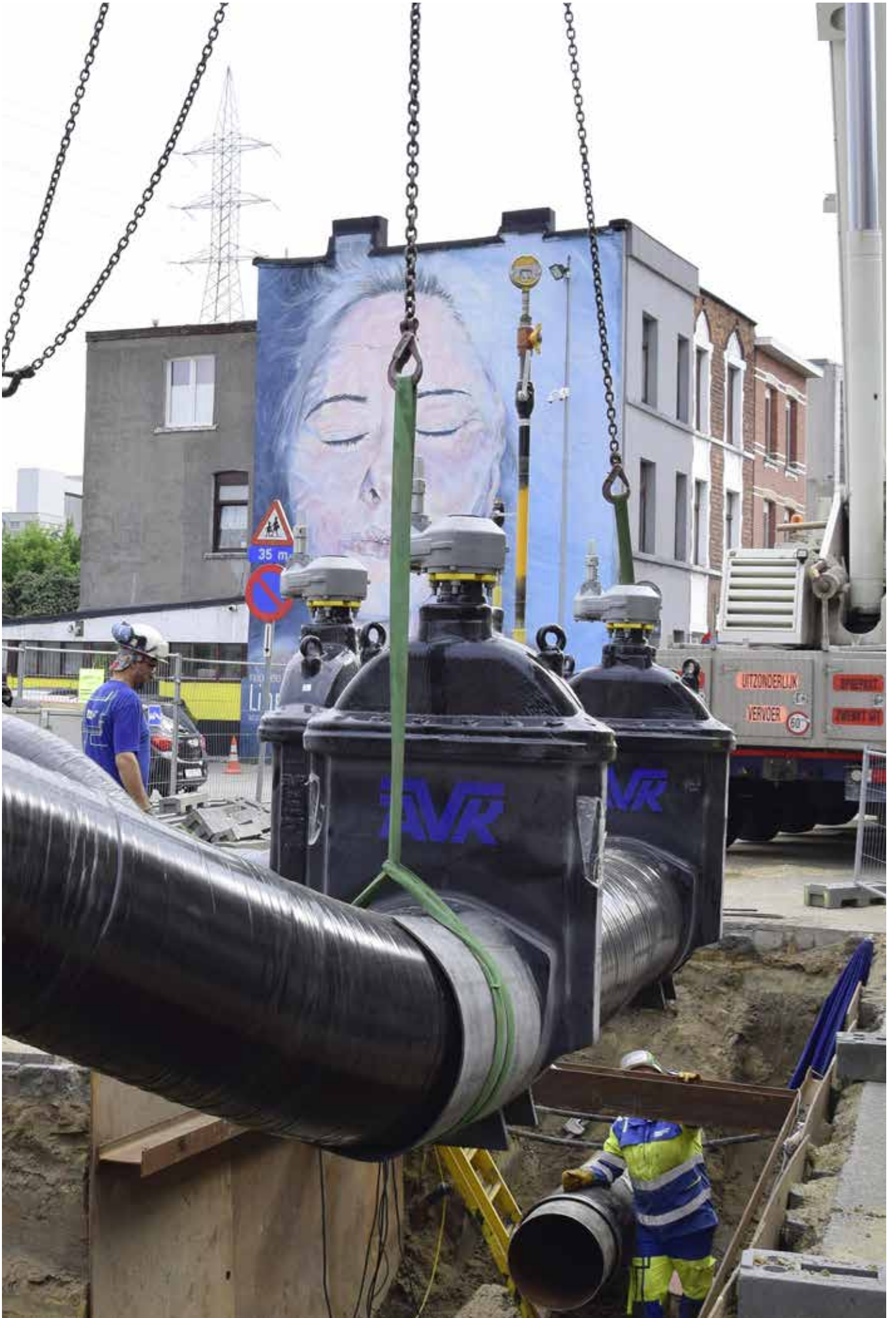

**AVK International A/S**

Bizonvej 1  
Skovby  
8464 Galten  
Denmark

Tel.: +45 8754 2100  
[www.avkvalves.eu](http://www.avkvalves.eu)

2022-11-17  
© 2022 AVK Group A/S - rev. 1

Expect... **AVK**

